

REVISIONS		
ISS	ZONE	DESCRIPTION\PER REQUEST\DATE
V	OPEN	對客戶公開圖紙
	OPEN	對供應商公開圖紙
	CLOSED	僅限廠內使用

台灣日昇電子股份有限公司
ISSUE APPROVED
 發行核可
本文件與簽核紙本正本相符

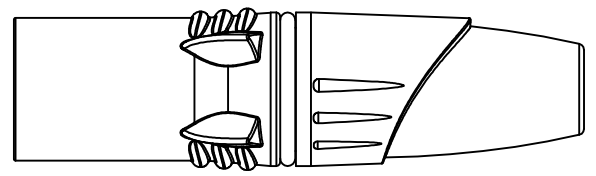
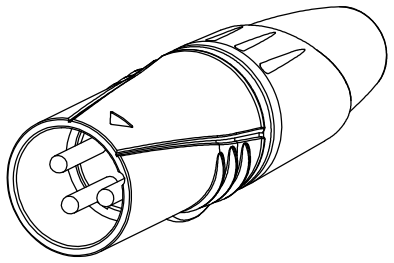
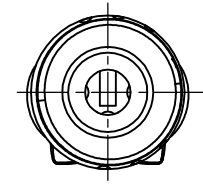
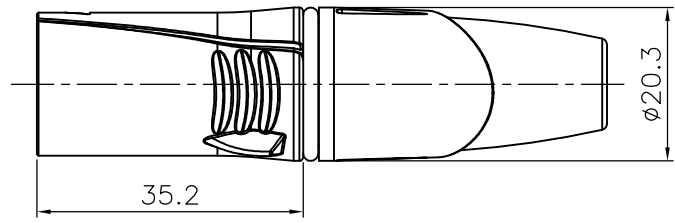
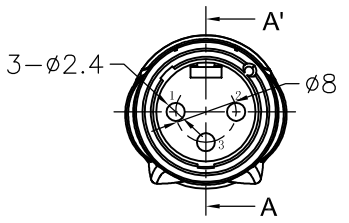
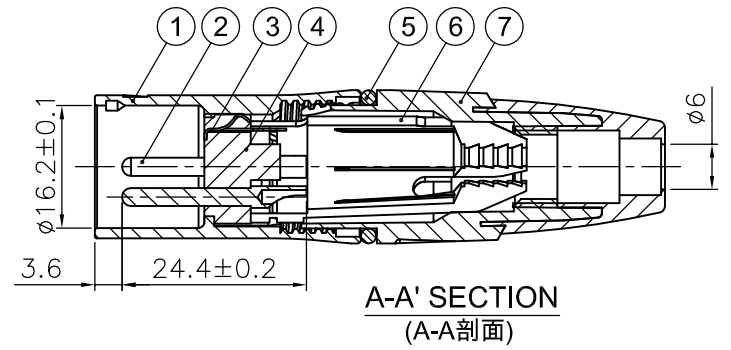
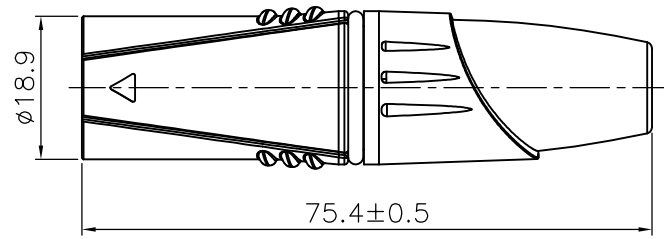

Notes(備註):
 1. Without any logo on insulator and shell (塑粒和外殼上不要有任何標誌)
 ★2. Remove O-ring used for cable O.D.: 3.3~4.8mm, Standard connector used for cable O.D.: 5.0~7mm (拿掉O型圈適用線徑3.3~4.8mm, 標準接頭適用線徑5.0~7mm)

NO.	DESCRIPTION	MATERIAL	FINISH	Q'TY	DRAWING NO.
7	螺套+尾套(CAP+BOOT)	PA6+TPR	黑+灰(BK+GY)	1	4301060117
6	夾線爪(CABLE CLAMP)	POM	白色(WHITE)	1	4301070022
5	O型圈(O-RING)	SILICON	黑色(BLACK)	1	1209100039
4	塑粒(INSULATOR)	PA	黑色(BLACK)	1	4401110119
3	接地片(GROUND)	H62	鍍錫(TIN)	1	(SVP555S-0-NL)
2	插針(PIN)	H59-1	鍍銀(SILVER)	3	
1	鋅殼(DIE CAST SHELL)	ZZnAL4-1	鍍鎳(NICKEL)	1	3103040165

DIMENSIONS ARE IN MILLIMETERS		APPROVED	DATE 2019-02-25
UNLESS OTHERWISE SPECIFIED TOLERANCES		CHECKED	DATE
ANGLES = ±5°		DRAWN 吳碧珊	DATE 2019-02-15
UP TO 6 = ±0.2		FILE NO. D:\CAD\SVP555\5111070455_	
6-40 = ±0.4		SVP555V-NL_CA001A1	
40-120 = ±0.6		ERP LINK: 5111070455	
120-315 = ±1			
ABOVE 315 = ±1.6			
THIRD_ANGLE			
SCALE	1/1		

	日昇電子股份有限公司 SUN RISE EXACT INDUSTRIAL CO.	
	TITLE 3PIN XLR MALE CONNECTOR	
PART NO.	SVP555V-NL	REV. A1